



VOLTAMPERE

VOLTAMPERE



PRODUCT CATALOGUE 2020

www.voltampere-eu.com



VOLTAMPERE





VOLTAMPERE



ABOUT US

More about VOLTAMPERE LIGHTING

A Greece-based professional smart solution

Provider of digital lighting technology, which provides High-quality luminaires that can be expanded with Additional sensor parts, making them a source and data generating location with available connectivity whenever and wherever the customer needs.

Since our inception, we have offered state-of-the-art LED luminaires, implemented exceptional LED projects, been recognized and widely accepted by major consultants

& developers. We actively advance the technology

in order to create more energy-efficient and higher quality products for our customers.

VOLTAMPERE LIGHTING FOCUS ON:

- General Lighting and Luminaires

- Projects and Lighting Solutions

- High Customization Level

SPECIAL REQUEST FACTORY

Our special request factory provides us with unrivalled flexibility, which allows us to make very small and precise parts with ease and at speed.

LED PRODUCTION

All of our LED chips are soldered using the selective wave method, and all components and final products are thoroughly tested using precision equipment in line with stringent technical standards.

Residential

VOLTAMPERE LIGHTING residential luminaire selection is extremely wide and designed to cover all professional needs in general lighting at home as well as in public premises.

Public premises

Efficient and functional lighting enhances productivity and improves performance where ever we work. VOLTAMPERE LIGHTING public premises luminaires can be designed and installed to make the best possible lighting for each situation.

Industrial

VOLTAMPERE LIGHTING solves industrial lighting needs. Paper mill or parking hall; our efficient, wide and light technically superior portfolio suits almost everywhere.

Outdoor

VOLTAMPERE LIGHTING outdoor luminaire selection is energy efficient, long lasting and economically sustainable. We know how to light parks, squares as well as yards and parking areas.

VOLTAMPERE

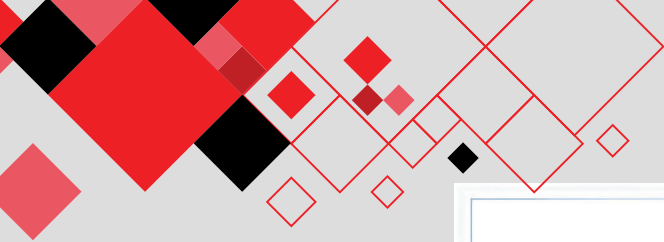

C E R T I F I C A T E
of Conformity
Low Voltage Directive 2014/35/EU



Registration No.: AN 50433471 0001
Report No.: 50168133 001

Holder: Greece Voltampere Technology Co., Ltd.
2Nd KL Lagadas-Redine
GR.572 00 Thessaloniti,
Greece, Europe

Product: Recessed Luminaire
(LED Recessed light)

Identification:

DD0035A	DD0035X	DD0045X	DD0055W	DD0055L	DD0055X
DD0075C	DD0075X	DD0085X	DD0095X	DD0105X	DD0115X
DD0125X	DD0135X	DD0145X	DD0155X	DD0165X	DD0175X

Serial No.: n.a.
Remark: Refer to test report 50168133 001 for a details.

This certificate of conformity is based on an evaluation of a sample of the above mentioned product. Technical Report and documentation are at the License Holder's disposal. This is to certify that the tested sample is in conformity with Annex I of Council Directive 2014/35/EU, referred to as the Low Voltage Directive. This certificate does not imply assessment of the series-production of the product and does not permit the use of a TÜV Rheinland mark of conformity. The holder of the certificate is authorized to use this certificate in connection with the EC declaration of conformity according to Annex IV of the Directive.

Eileen Feng
Eileen Feng

Date: 29_05_2020

TÜV Rheinland LGA Products GmbH - Tillystraße 2 - 90431 Nürnberg

CE The CE marking may be used if all relevant and effective EC Directives are complied with. **CE**

TÜV Rheinland (China) Ltd.
Member of TÜV Rheinland Group

 **TÜVRheinland®**
Precisely Right.

Greece Voltampere Technology Co., Ltd. Date : 29.05.2020
2Nd KL Lagadas-Redine Our ref. : ILD 05
GR.572 00 Thessaloniti, Your ref.:
Greece, Europe

Ref : AN Certificate of Conf. Low Voltage D.

Type of Equipment : LED Recessed light
Model Designation : See Certificate
Certificate No. : AN 50433471 0001
Report No. : 50168133 001

Dear Nicole Liang,

We herewith confirm that a sample of the above mentioned technical equipment has been tested and was found to be in accordance with the relevant requirements.

Enclosed please find your Certificate of Conformity.

We appreciate your kind support and would like to offer our assistance and continuous services in the future.

With kind regards,
Certification Body
Eileen Feng
Eileen Feng

Enclosure



VOLTAMPERE

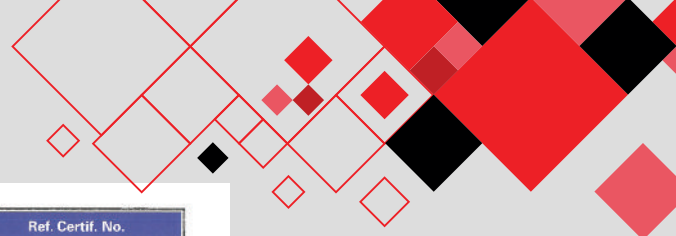

		Ref. Certif. No. DE 2-024829
IEC SYSTEM FOR MUTUAL RECOGNITION OF TEST CERTIFICATES FOR ELECTRICAL EQUIPMENT (IECEE) CB SCHEME		
CB TEST CERTIFICATE		
Product	LED Recessed LIGHT	
Name and address of the applicant	Greece Voltampere Technology Co., Ltd 2Nd Kl. Lagadas-Redine GR.572 00 Thessaloniki, Greece, Europe	
Name and address of the manufacturer	Greece Voltampere Technology Co., Ltd. 2Nd Kl. Lagadas-Redine GR.572 00 Thessaloniki, Greece, Europe	
Name and address of the factory	Greece Voltampere Technology Co., Ltd. 2Nd Kl. Lagadas-Redine GR.572 00 Thessaloniki, Greece, Europe	
Ratings and principal characteristics	100-240VAC, 50/60Hz; IP20, Class II For rated power, refer to the test report.	
Trademark (if any)	VOLTAMPERE	
Customer's Testing Facility (CTF) Stage used		
Model / Type Ref.	DDDaab, DTDaadb, DD'Yaab, DEYaab For detailed listing of variables see, B refer to test report.	
Additional information (if necessary may also be reported on page 2)	For model differences, refer to the test report	
A sample of the product was tested and found to be in conformity with	IEC 60598-2-2:2011 IEC 60598-1:2014 See Test Report for National Differences	
As shown in the Test Report Ref. No. which forms part of this Certificate	5018132_001	
This CB Test Certificate is issued by the National Certification Body		
TÜV Rheinland LGA Products GmbH Tillystraße 7 • 90431 Nürnberg, Germany Phone: +49 221 806-1371 Fax: +49 221 806-3935 Mail: cert-validity@de.tuv.com Web: www.tuv.com		Eileen Feng
Date: 29. 05. 2020	Signature: Eileen Feng	

TÜVRheinland®
Precisely Right.

Business Stream Products
Certification Department

TÜV Rheinland LGA Products GmbH • 90431 Nürnberg

Greece Voltampere Technology Co., Ltd.
2Nd Kl. Lagadas-Redine
GR.572 00 Thessaloniki,
Greece, Europe

Contact:
Tel: +49 911 655-5225
Mail: service@de.tuv.com
29. 05. 2020

Application for : CB-Zertifikat
Certificate No. : DE 02024829
Device : Recessed Luminaire
LED Recessed Light
Type : see Certificate
Test requirement : IEC 60598-2-2:2011
IEC 60598-1:2014
See Test Report for National Differences

Dear Madame or Sir,

The submitted sample of the product has been tested and in this configuration found to be in accordance with the above mentioned requirements.
Enclosed please find the certificate No. DE 02024829.

Kind regards

Certification body

 Eileen Feng
 Test sample: no, documentation available

TÜV Rheinland
LGA Products GmbH
Tillystraße 7
90431 Nürnberg
Tel: +49 911 655-5225
Fax: +49 911 655-5228
Mail: service@de.tuv.com
Web: www.tuv.com/led

Board of Management
 Dipl.-Ing.
 Jörg Meiser, Spokesman
 Dipl.-Kfm.
 Dr. Jörg Schneider
 Chairman of the
 Supervisory Board
 Dipl.-Ing.
 Ralf Scheider
 Nürnberg HRB 26013
 VAT No.: DE 811 634420

2020 01 20 IECB IECB 004 TÜV Rheinland AG Nürnberg



INDOOR LIGHT



01-Spot Lights
08 ~ 63 Page



02-Down Lights
64 ~ 75 Page



03-Track Lights
76 ~ 101 Page



Greece



04-Magnetic System
102 ~ 127 Page

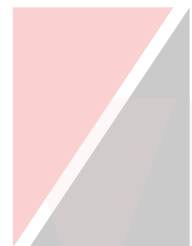

VOLTAMPERE

VOLTAMPERE



05-Pendant Light
126 ~ 137 Page



06-Strip Light
138 ~ 167 Page



07-LED Bulb
168 ~ 175Page



VOLTAMPERE



OUTDOOR LIGHT



01-Cilling Surface Mounted
178 ~ 193 Page



02-Wall Lighting
194 ~ 203 Page



Greece



VOLTAMPERE

VOLTAMPERE



03-UnderGround light
204 ~ 219 Page



04-Bollard Light
220 ~ 223 Page

CILING SURFACE MOUNTED





Ruler

Outdoor Ceiling Lamp

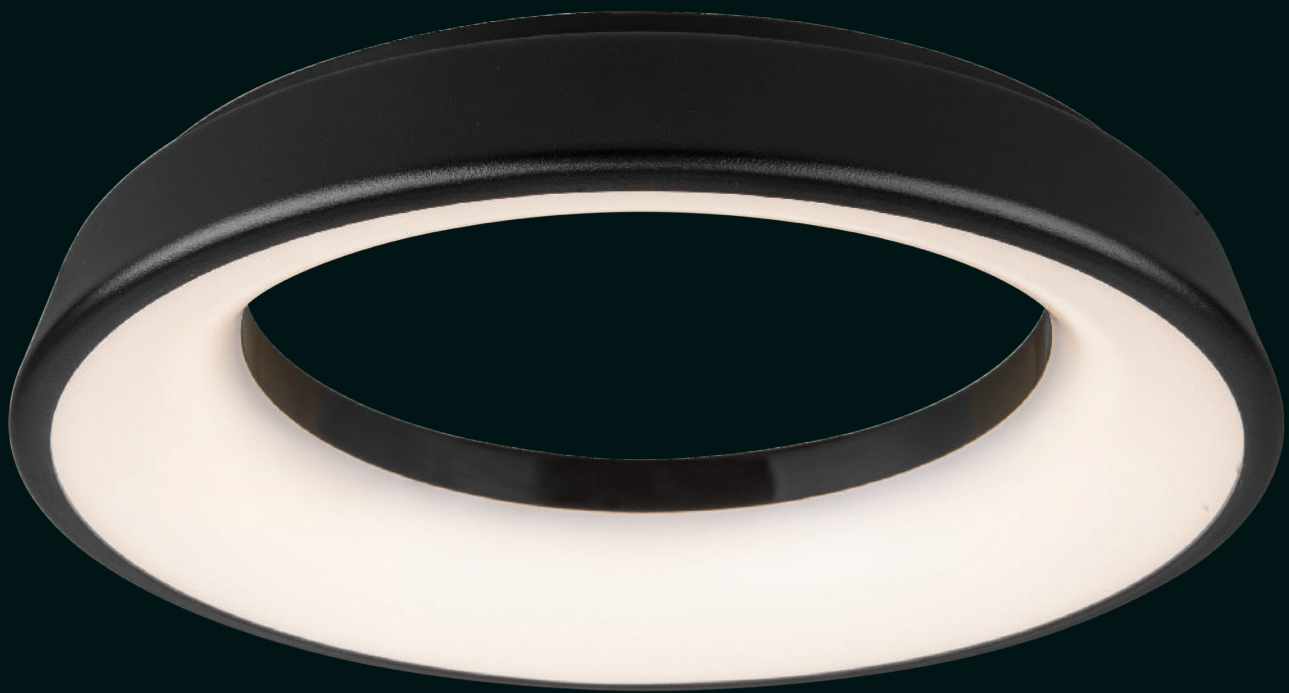





Ruler

Outdoor Ceiling Lamp



- Simple round and square structure.
- Waterproof, dustproof, pressure and corrosion resistant.
- Mainly for balcony and gazebo.

Surface
Luminescence
120°+





VOLTAMPERE



SPECIFICATION



Code	Power	Light Source	Light Output	Size(DxH)	Driver
VAXFL175	1x25W	EPISTAR SMD	1750 lm	Φ300x50mm	300mA
VAXFL175A	1x35W	EPISTAR SMD	2500 lm	Φ361x55mm	450mA

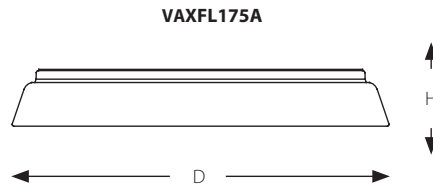
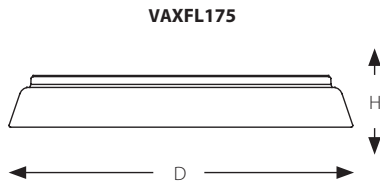

Finishing: ○ White ● Black ● Silver

CCT: ● 2700K ● 3000K ● 4000K ● 5000K

CRI: 80 / 90

Photometric

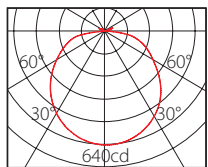

VAXFL175 25W		3000K	
H(m)	E _{max} (Lux)	L(cm)	W(cm)
1	508	358	358
2	127	716	716
3	56	1074	1074
4	32	1432	1432
5	20	1790	1790

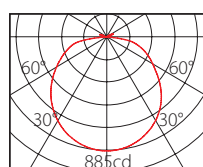

VAXFL175A 35W		3000K	
H(m)	E _{max} (Lux)	L(cm)	W(cm)
1	706	381	381
2	177	762	762
3	78	1144	1144
4	44	1525	1525
5	28	1906	1906

LED Drivers
PHILIPS TRIDONIC
 VOLTAMPERE

LED Chips
BRIDGELUX PHILIPS
SAMSUNG CREE



VOLTAMPERE

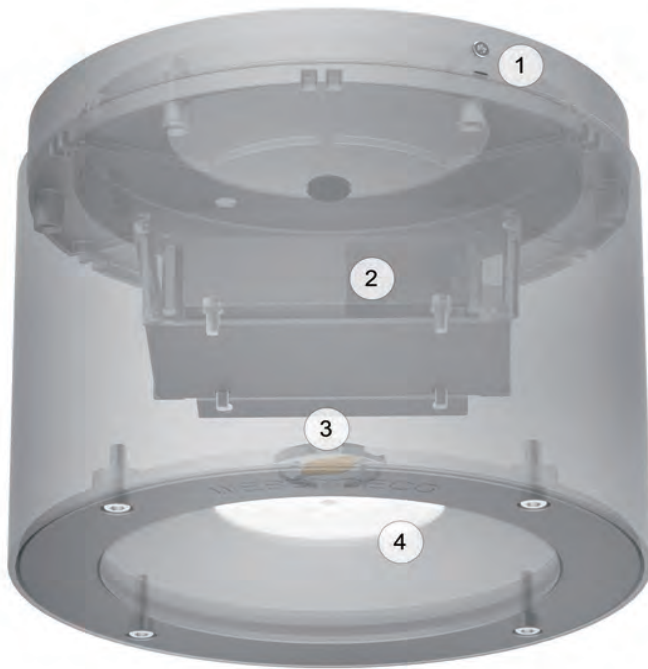

- 1. Flush Ceiling mounted, no gap occurred between ceiling and luminaries
- 2. Integrated LED driver.
- 3. COB lamp module with advanced optical design
- 4. Deep anti-glare louver

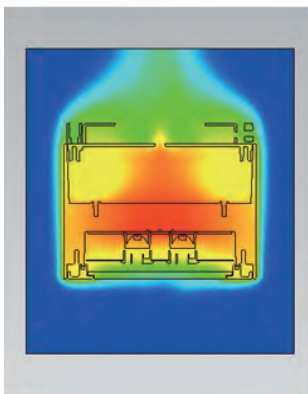

Excellent heat dissipation

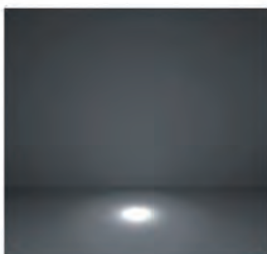

10°

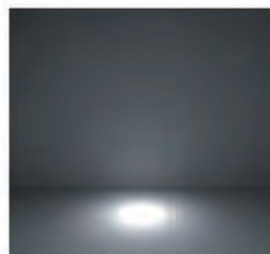

25°

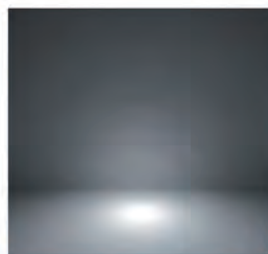

40°

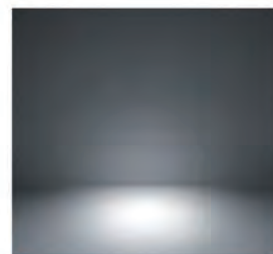

60°

Different options of beam angle light distribution





VOLTAMPERE

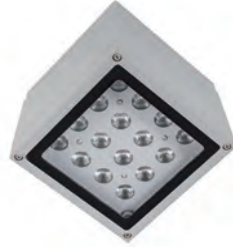

Square and cylinder
typical design in
different sizes

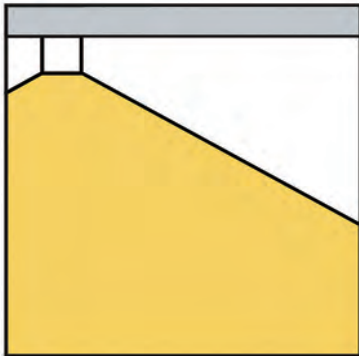

30~40deg optical cut-off achieve
maximum visual comfort

LED Drivers
PHILIPS TRIDONIC
VOLTAMPERE

LED Chips
BRIDGELUX PHILIPS
SAMSUNG CREE



VOLTAMPERE



VA60.8503



Standard color



Optional color

- Material:** ADC12 corrosion-resistant die-cast aluminum housing;
304 stainless steel external fasten screws;
Anti-aging waterproof silicone gasket;
3mm clear safety glass
- Finishing:** Double layers of DUPONT UV-resistant polyester powder coating
- Installation:** Ambient temperature: -30°C~ +45°C
Single color: 1x0.4m length 2/3cores Ø7.0mm power supply cable;
DMX512 controllable: 1x0.4m length 2/3 cores Ø7.0mm power supply cable;
2x0.4m length 4 cores Ø6.0mm signal supply cable;
Nickled plated brass waterproof cable gland
- Packaging:** Net weight: 2.2kg
Outer carton: 570x380x350mm(12pcs/ctn)





VOLTAMPERE



LED Drivers
PHILIPS TRIDONIC
VOLTAMPERE

LED Chips
BRIDGELUX PHILIPS
SAMSUNG CREE



VOLTAMPERE 187



VOLTAMPERE

VA60.8503

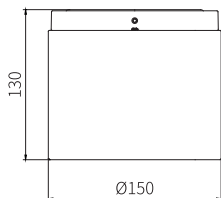
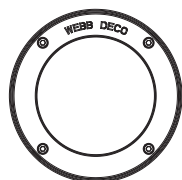

LED 24W
4000k
10°

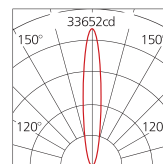
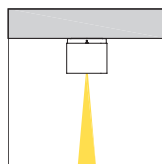

H(m)	medlux	maxlux
2.0	7480	11000
5.0	1209	1750
10.0	280	415
20.0	70	105

LED 24W
4000k
25°

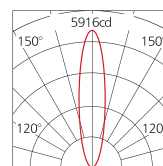
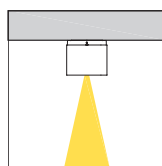

H(m)	medlux	maxlux
2.0	1180	2210
5.0	242	347
10.0	54	83
20.0	14	22

LED 24W
4000k
40°

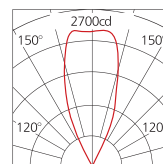
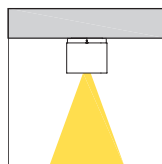

H(m)	medlux	maxlux
2.0	616	849
5.0	88.6	144
10.0	24	34
20.0	10.6	14.6

LED 24W
4000k
60°

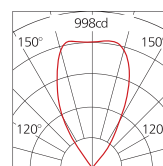
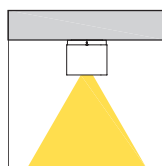

H(m)	medlux	maxlux
2.0	241.8	322.9
5.0	32.7	46.8
10.0	7.8	10.9
20.0	2.3	5.4





VOLTAMPERE



Model No.	LED Qty X Power	LED Color	CRI	Light source Luminous Flux @4000K	System Power	Luminaire Luminous Flux @4000K	Luminaire Efficacy	Control Mode	Beam Angle
VA60.8503.A12V24	12X2W	2200K-5700K	Ra>80	3120lm	24W	2300lm	95.8lm/W	ON/OFF	10° /25° /40° /60°
VA60.8503.A12V220	12X2W	2200K-5700K	Ra>80	3120lm	27W	2300lm	85lm/W	ON/OFF	10° /25° /40° /60°
VA60.8503.A12FV220	12X2W	RGB		1008lm	27W	770lm	28.5lm/W	DMX512	10° /25° /40° /60°
VA60.8503.B1V220	1X21W	2700K-5700K	Ra>80	2850lm	24W	1990lm	83lm/W	ON/OFF	15° /25° /40° /60°

Installation:

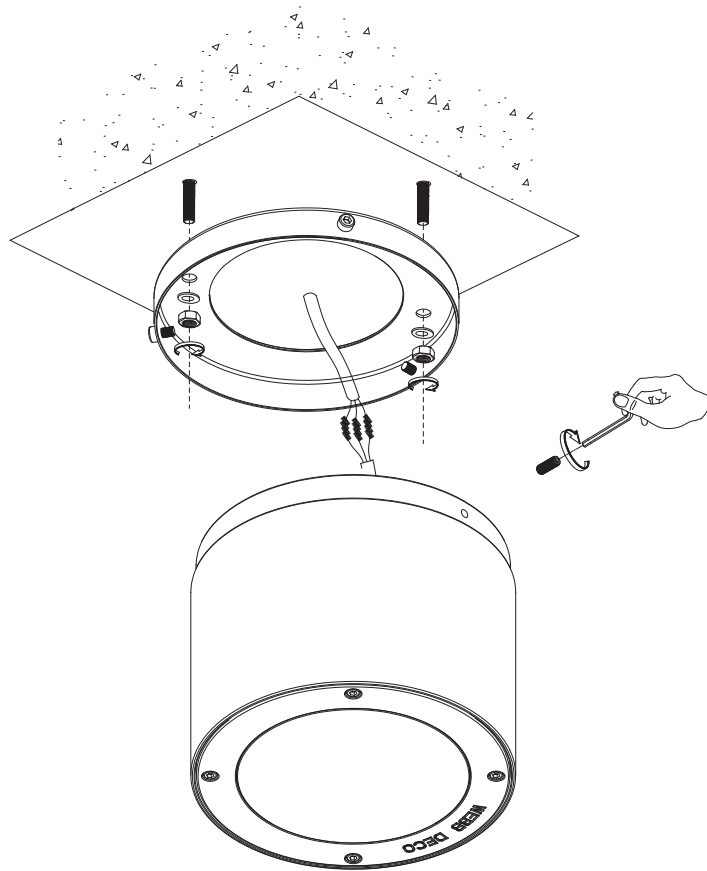



VA60.8504



Standard color



Optional color

- Material:** ADC12 corrosion-resistant die-cast aluminum housing;
304 stainless steel external fasten screws;
Anti-aging waterproof silicone gasket;
3mm clear safety glass
- Finishing:** Double layers of DUPONT UV-resistant polyester powder coating
- Installation:** Ambient temperature: -30°C ~ +45°C
Single color: 1x0.4m length 3cores Ø7.0mm power supply cable;
DMX512 controllable: 1x0.4m length 3cores Ø7.0mm power supply cable;
2x0.4m length 4 cores Ø6.0mm signal supply cable;
Nickled plated brass waterproof cable gland
- Packaging:** Net weight: 4.8kg
Outer carton: 485x480x220mm(4pcs/ctn)





VOLTAMPERE

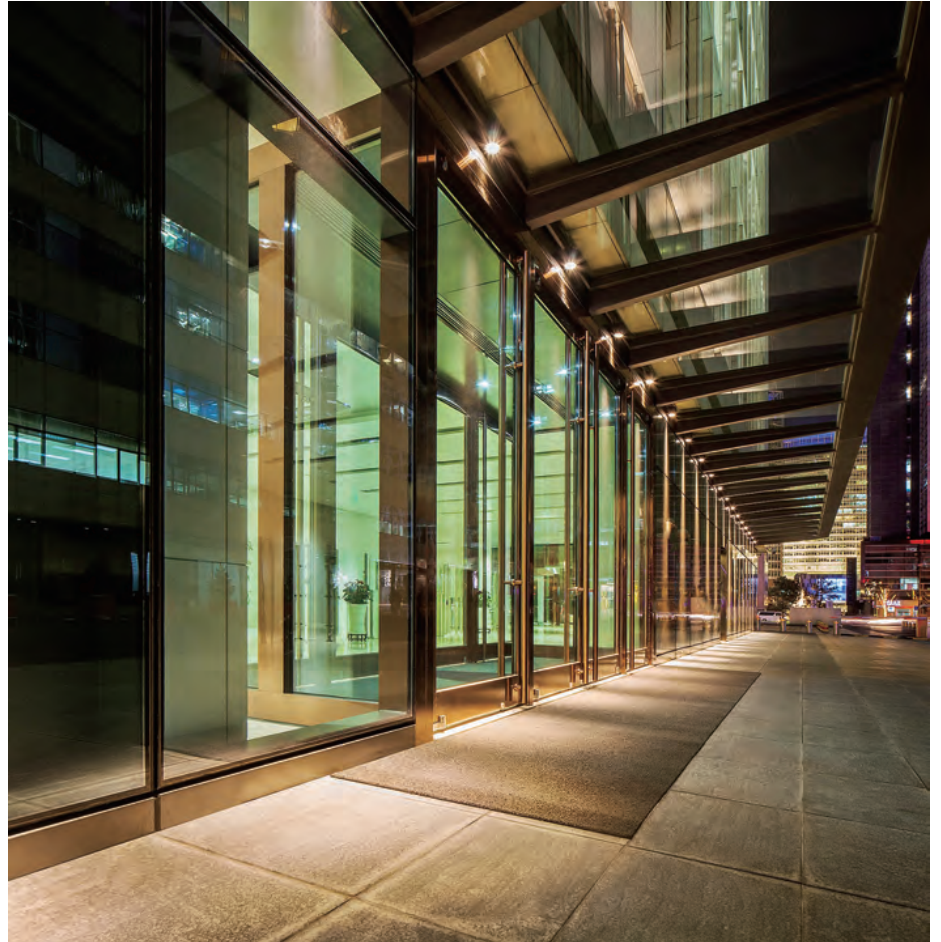

LED Drivers
PHILIPS TRIDONIC
VOLTAMPERE

LED Chips
BRIDGELUX PHILIPS
SAMSUNG CREE



VOLTAMPERE



VOLTAMPERE

VA60.8504

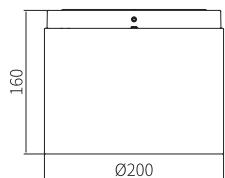
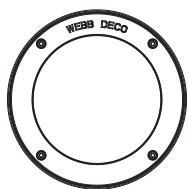

LED 40W
4000k
10°

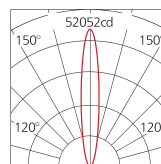
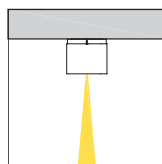

H(m)	medlux	maxlux
2.0	11250	17000
5.0	1809	2400
10.0	420	635
20.0	115	165

LED 40W
4000k
25°

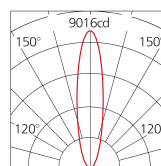
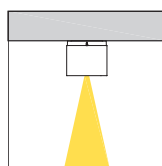

H(m)	medlux	maxlux
2.0	1180	2210
5.0	242	347
10.0	54	83
20.0	14	22

LED 40W
4000k
40°

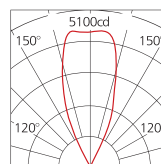
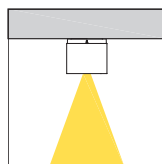

H(m)	medlux	maxlux
2.0	616	849
5.0	88.6	144
10.0	24	34
20.0	10.6	14.6

LED 40W
4000k
60°

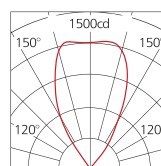
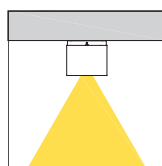

H(m)	medlux	maxlux
2.0	241.8	322.9
5.0	32.7	46.8
10.0	7.8	10.9
20.0	2.3	5.4





VOLTAMPERE



Model No.	LED Qty X Power	LED Color	CRI	Light source Luminous Flux @4000K	System Power	Luminaire Luminous Flux @4000K	Luminaire Efficacy	Control Mode	Beam Angle
VA60.8504.A18V220	18X2W	2200K-5700K	Ra>80	4680lm	40W	3650lm	91lm/W	ON/OFF	10° /25° /40° /60°
VA60.8504.A18FV220	18X2W	RGB		1515lm	40W	1160lm	29lm/W	DMX512	10° /25° /40° /60°
VA60.8504.B1V220	1X36W	2700K-5700K	Ra>80	5040lm	40W	3500lm	87lm/W	ON/OFF	15° /25° /40° /60°

Installation:

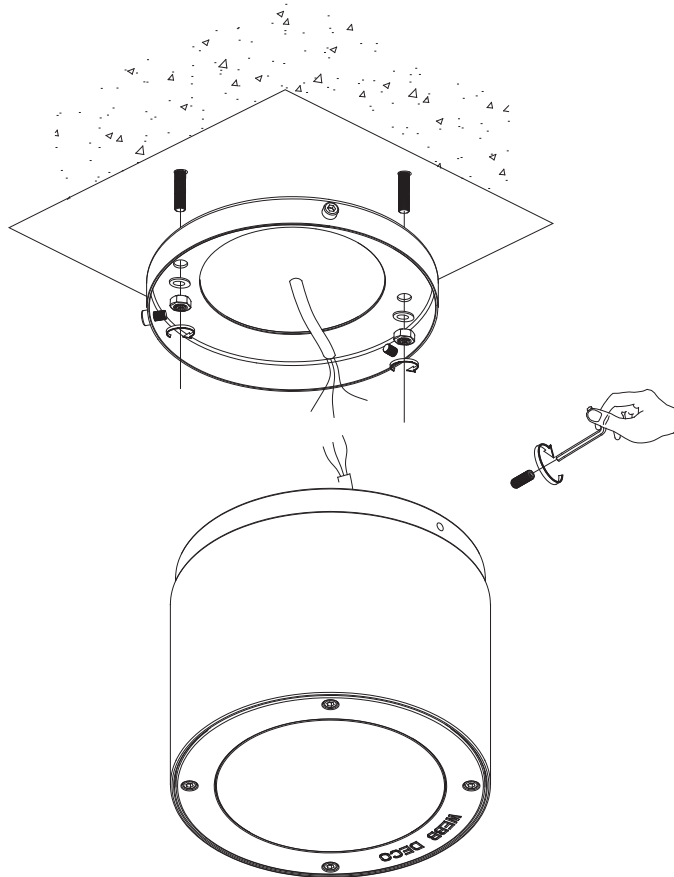

LED Drivers
PHILIPS TRIDONIC
 VOLTAMPERE

LED Chips
BRIDGELUX PHILIPS
SAMSUNG CREE



VOLTAMPERE



VOLTAMPERE



2Nd KL Lagadas-Redine
GR.572 00 Thessaloniti,
Greece, Europe

Contact us:
T:+ 30 690 898 9002
E: info@voltampere-eu.com

www.voltampere-eu.com